

OD172S Series

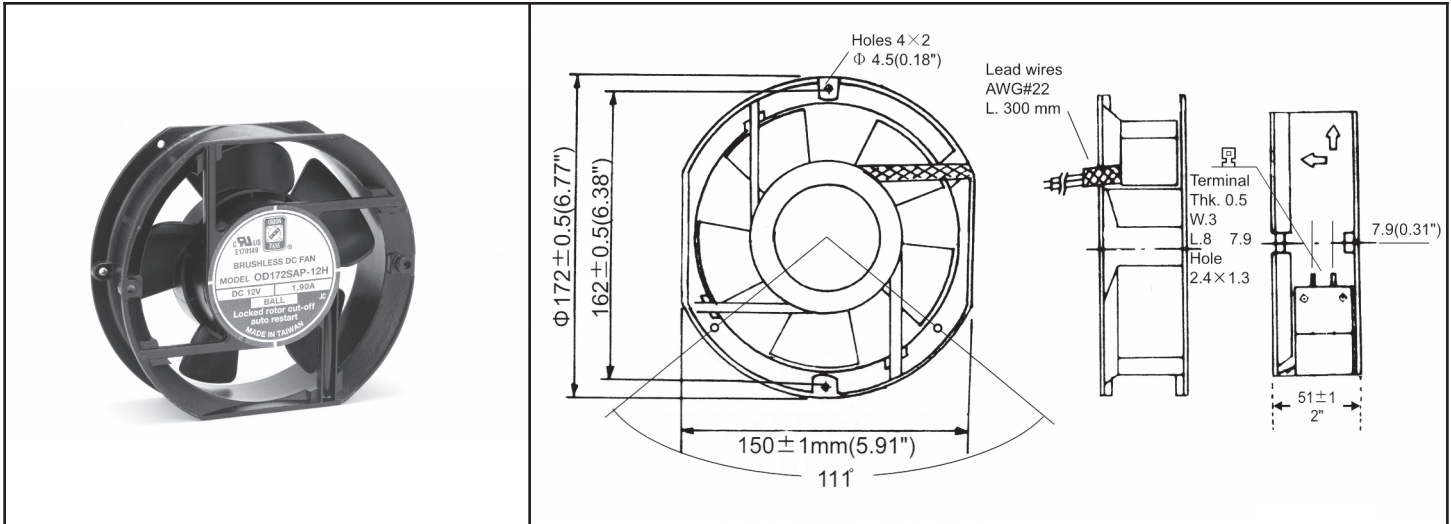

DC Fan - 12, 24, 48V
172x150x51mm (6.7"x 5.9"x 2.0")



Frame	Diecast Aluminum	Available Options: Tachometer Alarm Thermistor Speed Control PWM Speed Control <u>Life Expectancy (L10)</u> Ball - 40,000 hrs (60C) <u>Operating Temperature</u> Ball: -20C ~ +75C Weight: ~1.8 lbs m0	
Impeller	PBT, UL94V-0 plastic		
Connection	2x Lead wires, AWG22 or terminals		
Motor	Brushless DC, auto restart, polarity protected		
Bearing System	Dual ball bearing		
Insulation Resistance	10M ohm between leadwire and frame (500VDC)		
Dielectric Strength	1 minute at 500 VAC, max leakage < 500 MicroAmp		
Storage Temperature	-40C ~ +80C		

Model Number	Speed (RPM)	Airflow (CFM)	Noise (dB)	Volts DC	Voltage Range	Amps	Max. Static Pressure (\"H ₂ O)
OD172SAP-12HH *	3800	290	56	12	8~14	2.90	0.93
OD172SAP-12H *	3200	230	52	12	8~14	1.90	0.75
OD172SAP-12M *	2500	180	42	12	8~14	1.10	0.51
OD172SAP-12L *	1600	125	32	12	8~14	0.45	0.35
OD172SAP-24HH *	3900	300	57	24	15~28	2.10	0.98
OD172SAP-24H *	3300	235	52	24	15~28	0.97	0.79
OD172SAP-24M *	2500	180	42	24	15~28	0.52	0.51
OD172SAP-24L *	1600	125	32	24	15~28	0.20	0.35
OD172SAP-48HH *	3900	300	57	48	22~53	0.69	0.98
OD172SAP-48H *	3300	235	52	48	22~53	0.48	0.79
OD172SAP-48M *	2500	180	42	48	22~53	0.30	0.51
OD172SAP-48L *	1600	125	32	48	22~53	0.12	0.35

* Indicate "B" for wire leads or "TB" for Terminals