

TITLE	SPECIFICATIONS FOR Infrared Array Sensor	PAGE	1/26
NAME	Infrared Array Sensor "Grid-EYE"		AMG88**

1. Name : Infrared Array Sensor "Grid-EYE"

2. Part No. :

2-1 Part No. System

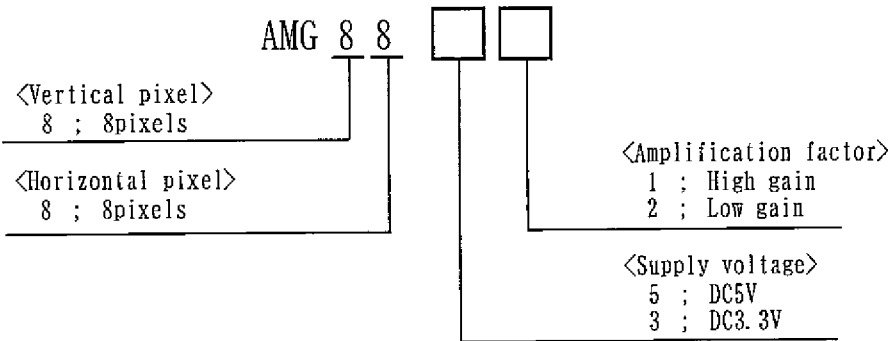

2-2 Part No. List

- AMG8831 (VDD=3.3V , High gain type)
- AMG8832 (VDD=3.3V , Low gain type)
- AMG8851 (VDD=5V , High gain type)
- AMG8852 (VDD=5V , Low gain type)

3. Drawing : AMG8851 Product drawing

4. Characteristics

4-1 Internal circuit

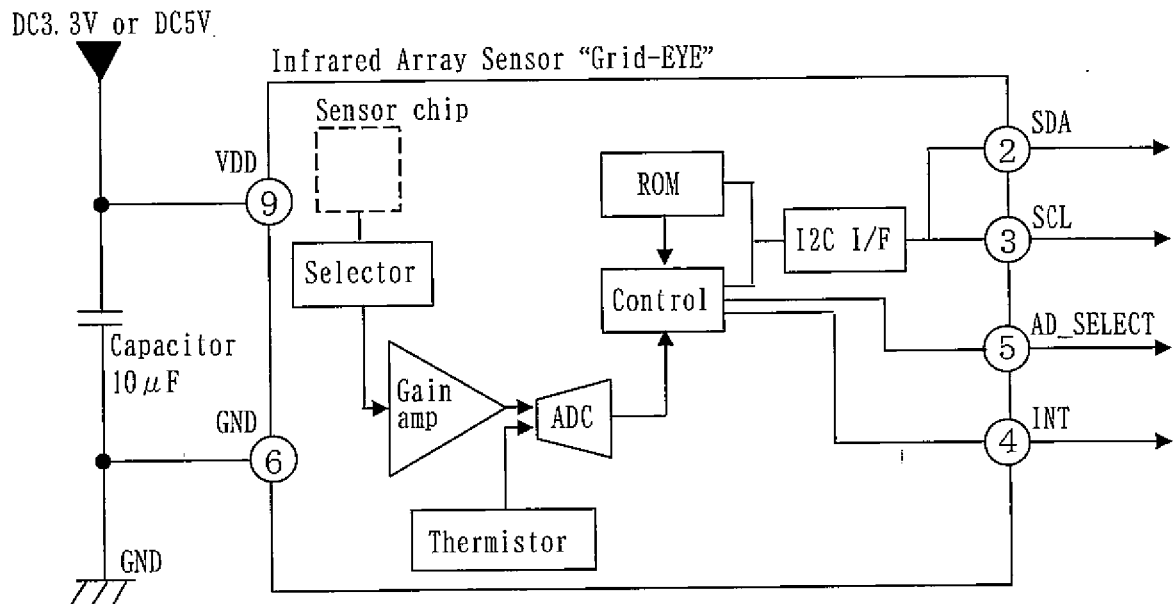

*④INT terminal normally has same voltage as VDD. When interrupting, same as GND (0V).
 *Regarding of recommended external circuit, please refer to section 4-9.

PANASONIC ELECTRIC WORKS, LTD.
 SWITCHING DEVICE DIVISION

DESIGNED
 CHECKED
 ENACTED

DESIGNED: J. Ise
 CHECKED: Yamamoto
 ENACTED: J. Yoshizawa
 REFERENCE ONLY
 MAY 15 2012
 Panasonic Corporation
 Ise Factory

DATE : Aug. 30. 2011

TITLE	SPECIFICATIONS FOR Infrared Array Sensor	PAGE	2/26
NAME	Infrared Array Sensor "Grid-EYE"		AMG88**

4-2 Main Functions

Item	Value
Pixel number	64 (8×8 Matrix)
External Interface	I ² C (fast mode)
Frame rate	Typ. 10 frames/sec or Typ. 1 frame/sec
Operating Mode	Normal Sleep Stand-by (10sec or 60sec intermittence)
Output Mode	Temperature Output
Calculate Mode	No moving average or Twice moving average
Temperature Output Resolution	0.25°C
Number of Sensor Addresses	2 (I ² C Slave Address)
Thermistor Output Temperature Range	-20°C~80°C
Thermistor Output Resolution	0.0625°C

4-3 Absolute Maximum Ratings

Item	Specification	Terminal
Applied voltage	-0.3~6.5V	VDD, VPP
Input/Output voltage	-0.3~V _{DD} +0.3V	SCL, SDA, AD_SELECT
Output current	-10~10mA	INT, SDA
ESD (Human Body Model)	1kV	All Terminals
ESD (Machine Model)	200V	All Terminals

4-4 Ratings

Item	Specification	
	High gain	Low gain
Applied voltage	3.3V±0.3V or 5.0V±0.5V	
Temperature Range of Measuring Object	0°C~80°C	-20°C~100°C
Operating temperature	0°C~80°C	-20°C~80°C
Storage temperature	-20°C~80°C	

REFERENCE ONLY

MAY 15 2012

DATE : Aug. 30. 2011

PANASONIC ELECTRIC WORKS, LTD. SWITCHING DEVICE DIVISION
Ise Factory

TITLE	SPECIFICATIONS FOR Infrared Array Sensor	PAGE	3/26
NAME	Infrared Array Sensor "Grid-EYE"		AMG88**

4-5 Characteristics

Item	Specification	
	High gain	Low gain
Temperature Accuracy	Within Typ. $\pm 2.5^{\circ}\text{C}$	Within Typ. $\pm 3.0^{\circ}\text{C}$
Rated detection distance *1	5m (Max.)	
Field of View	Typ. 60° (Horizontal, Vertical)	
Optical Axis Gap	Within Typ. $\pm 5.6^{\circ}$ (Horizontal, Vertical)	
Current Consumption	Typ. 4.5mA (normal mode) Typ. 0.2mA (sleep mode) Typ. 0.8mA (stand-by mode)	
Setup Time	Typ. 50msec (Time to enable Communication after Setup) Typ. 15sec (Time to stabilize Output after Setup)	

※1 · To have more than 4°C of temperature difference from background
· Detection object size : $700 \times 250\text{mm}$ (Assumable human body size)

4-6 Electric characteristics

(1) Characteristics of the SDA and SCL I/O stages

parameter	symbol	Min.	Max.	unit
Low level input voltage	V_{IL}	-0.3	$0.3 \times VDD$	V
High level input voltage	V_{IH}	$0.7 \times VDD$	$VDD + 0.3$	V
Hysteresis (SDA, SCL)	V_{hys}	$0.05 \times VDD$		V
Low level output voltage (at 3mA sink current)	V_{OL}	0	0.4	V
Output fall time from V_{IHmin} to V_{ILmax} with a bus capacitance from 10pF to 400pF	t_{of}	$20 + C_b$	250	ns
Pulse width of spikes which must be suppressed by the input filter	t_{sp}	0	50	ns
Input current each I/O pin with an input voltage between $0.1 \times VDD \sim 0.9 \times VDD$	I_I	-10	10	μA
Capacitance for each I/O pin	C_i	-	10	pF

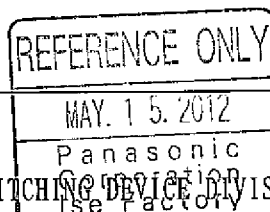

DATE : Aug. 30. 2011

TITLE	SPECIFICATIONS FOR Infrared Array Sensor	PAGE	4/26
NAME	Infrared Array Sensor "Grid-EYE"		AMG88**

(2) Characteristics of the SDA and SCL bus lines

parameter	symbol	Min.	Max.	unit
SCL clock frequency	f_{SCL}	0	400	kHz
Hold time (repeated) START condition.	$t_{HD:STA}$	600	-	ns
Low period of the SCL clock	t_{LOW}	1.3		μs
High period of the SCL clock	T_{HIGH}	0.6		μs
Set-up time for a repeated START condition	$t_{SU:STA}$	0.6		μs
Data hold time	$t_{HD:DAT}$	0	900	ns
Data set-up time	$t_{SU:DAT}$	100		ns
Rise time of both SDA and SCL signals ($f_{SCL} > 100\text{kHz}$)	t_r	$20+0.1 \times C_b$	300	ns
Rise time of both SDA and SCL signals ($f_{SCL} \leq 100\text{kHz}$)	t_r		1000	ns
Fall time of both SDA and SCL signals	t_f	$20+0.1 \times C_b$	300	ns
Set-up time for STOP condition	$t_{SU:STO}$	600		ns
Bus free time between a STOP and START condition	t_{BUF}	1300		ns
Capacitive load for each bus line	C_b		400	pF

REFERENCE ONLY
MAY 15 2012
Panasonic
SWITCHING DEVICE DIVISION
Ise Factory

DATE : Aug. 30. 2011

PANASONIC ELECTRIC WORKS, LTD. SWITCHING DEVICE DIVISION

4-7 Pixel Array & Viewing Field

(1) Pixel Array

Pixel Array from 1 to 64 is shown below.

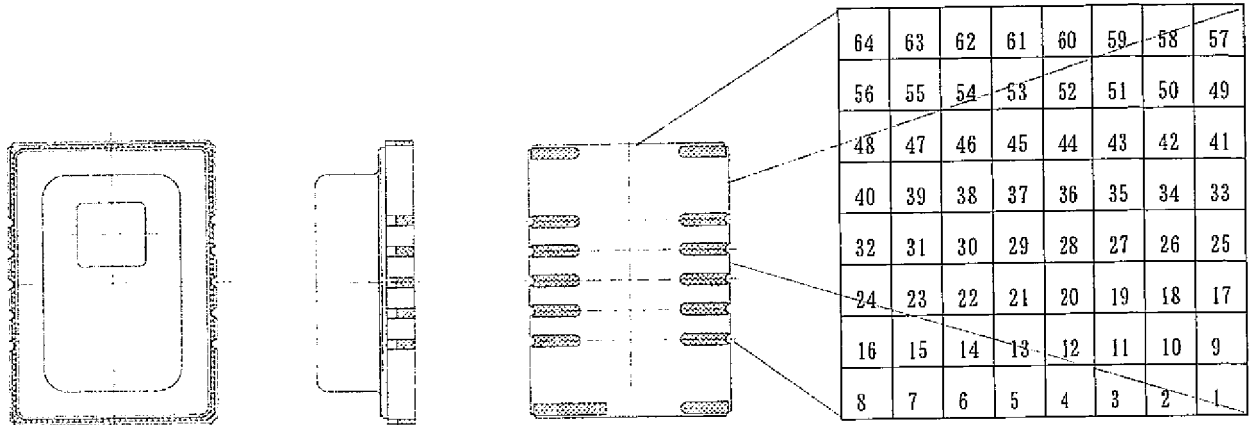

(2) Viewing Field

Sensor Viewing Field (Typical) is shown below.

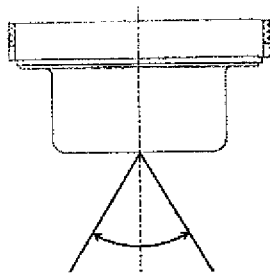

Horizontal viewing angle 60°

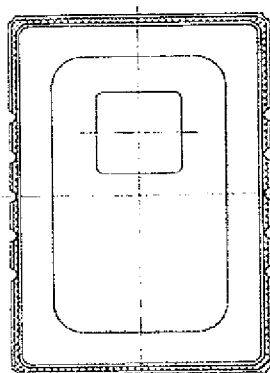

Vertical viewing angle 60°

REFERENCE ONLY
 MAY 15 2012
 Panasonic
 SWITCHING DEVICE DIVISION
 Ise Factory

DATE : Aug. 30. 2011

(3) Typical characteristics : Each pixel's viewing central angle
 *Regarding of Pixel Array, please refer to 4-7(1).

Sensor's optical center (the origin of graph below) gap
 : within Typ. $\pm 5.6^\circ$ (Both of horizontal and vertical directions)

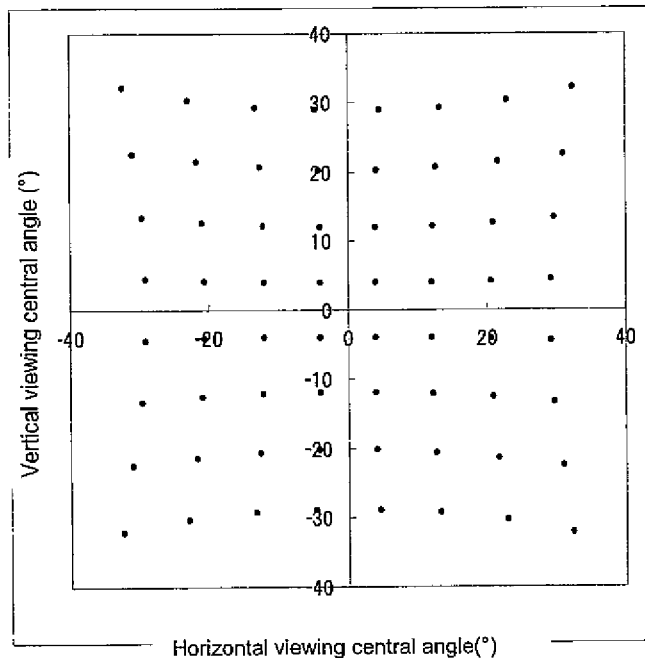

(4) Typical characteristics : Each pixel's viewing angle (half angle)
 Central 4 pixels (Pixel No. 28, 29, 36, 37) viewing angle (half angle) :
 horizontal direction Typ. 7.7°
 vertical direction Typ. 8°

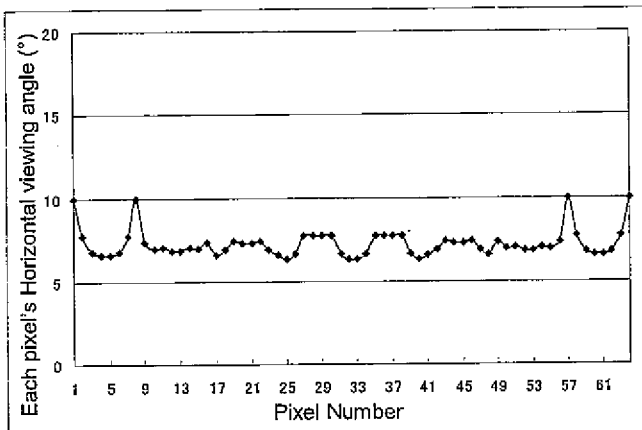

Each pixel's Horizontal viewing angle

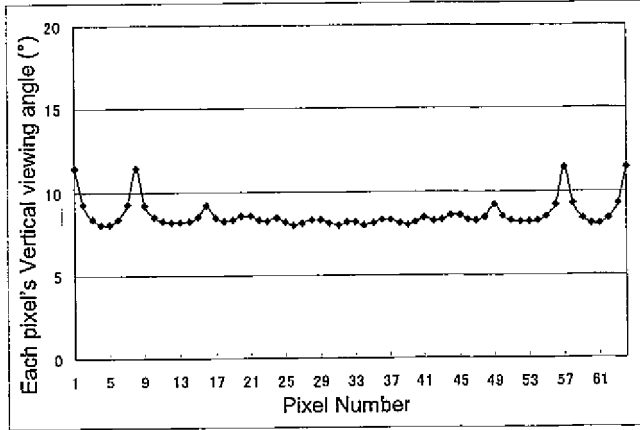

Each pixel's vertical viewing angle

TITLE	SPECIFICATIONS FOR Infrared Array Sensor	PAGE	7/26
NAME	Infrared Array Sensor "Grid-EYE"		AMG88**

4-8 Terminal's Function

Please refer to product drawing about pin assignment.

*Please don't connect wires in (NC) terminals.

Terminal No.	Name	Function	I/O	Remarks
①	(NC)	-		
②	SDA	I ² C data line	I/O	
③	SCL	I ² C clock line	I	
④	INT	Interrupt flag -This flag indicates whether Interrupt is generated or not when INT control register is activated. · High (VDD) : Interrupt is not generated · Low (0V) : Interrupt is generated	0	Please refer to section 4-10 (4)
⑤	AD_SELECT	Sensor address setting -2 number settable with connecting to VDD or GND.	I	Please refer to section 4-9
⑥	GND	0V	I	
⑦	(NC)	-		
⑧	(NC)	-		
⑨	VDD	DC3.3V or DC5V	I	
⑩	AVDD-PC	Capacitor connected	I	Please refer to section 4-9
⑪	(NC)	-		
⑫	DVDD-PC	Capacitor connected	I	Please refer to section 4-9
⑬	VPP	VDD connection	I	
⑭	(NC)	-		

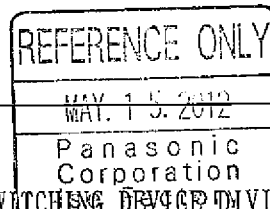

DATE : Aug. 30. 2011

TITLE	SPECIFICATIONS FOR Infrared Array Sensor	PAGE	8/26
NAME	Infrared Array Sensor "Grid-EYE"		AMG88**

4-9 Recommended External Circuit

This circuit is an example to drive Infrared Array Sensor "Grid-EYE", so that our company will not take any responsibility of loss which is due to this circuit.

- (1) In case of setting I²C slave address of the sensor 1101 000
 *Connect Terminal⑤ (AD_SELECT Terminal) to GND.

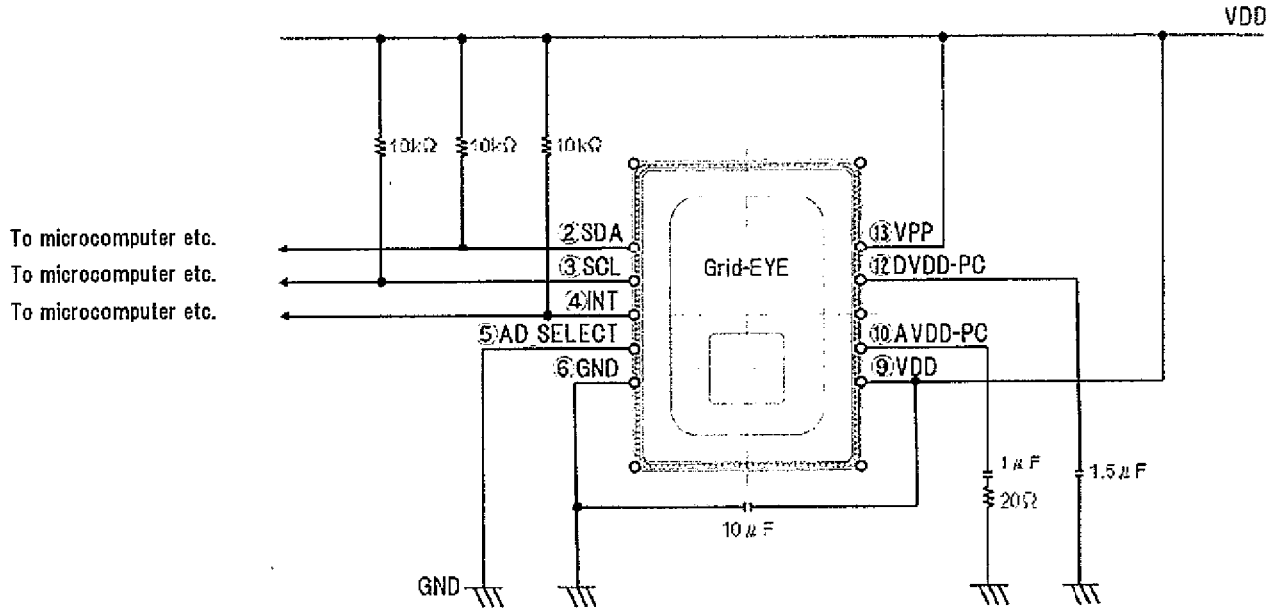

- (2) In case of setting I²C slave address of the sensor 1101 001
 *Connect Terminal⑤ (AD_SELECT Terminal) to VDD.

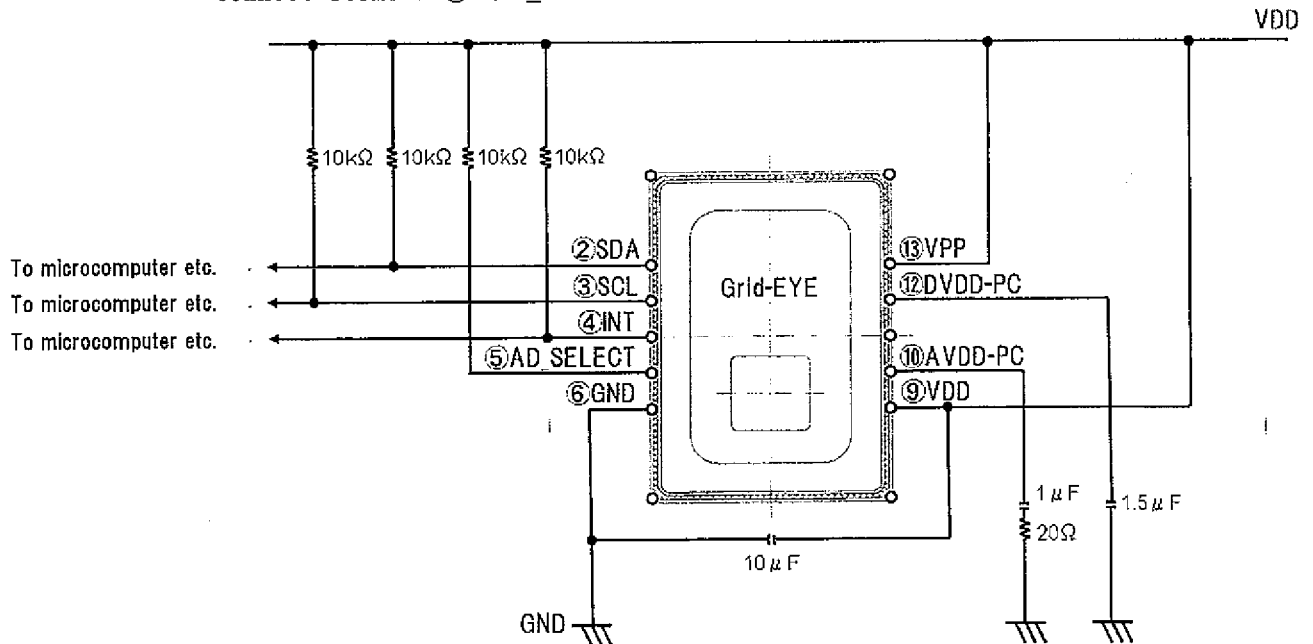

REFERENCE ONLY
 MAY. 15. 2012
 Panasonic
 Corporation
 SWITCHING DEVICE DIVISION

DATE: Aug. 30. 2011

4-10 Description of Functions

Registers shown below are possible to be set optionally.
 Take care to avoid writing register and bit which are not specified, it may cause of making proper operation impossible and causing a deterioration in its performance.

(1) Power Control Register

Register for setting operating mode of device.
 With setting provided command, changing to each operating mode is possible.

*Writing operation in Sleep mode is only active in return to Normal mode.
 (Command 0x00)

*Reading operation in Sleep mode is invalid.

address	register	R/W	bit7	bit6	bit5	bit4	bit3	bit2	bit1	bit0	Initial value	
0x00	PCTL	R/W	PCTL [7:0]									0x00

Command	Operating mode
0x00	Normal mode
0x10	Sleep mode
0x20	Stand-by mode (60sec intermittence)
0x21	Stand-by mode (10sec intermittence)

[Transition Diagram of Operating mode]

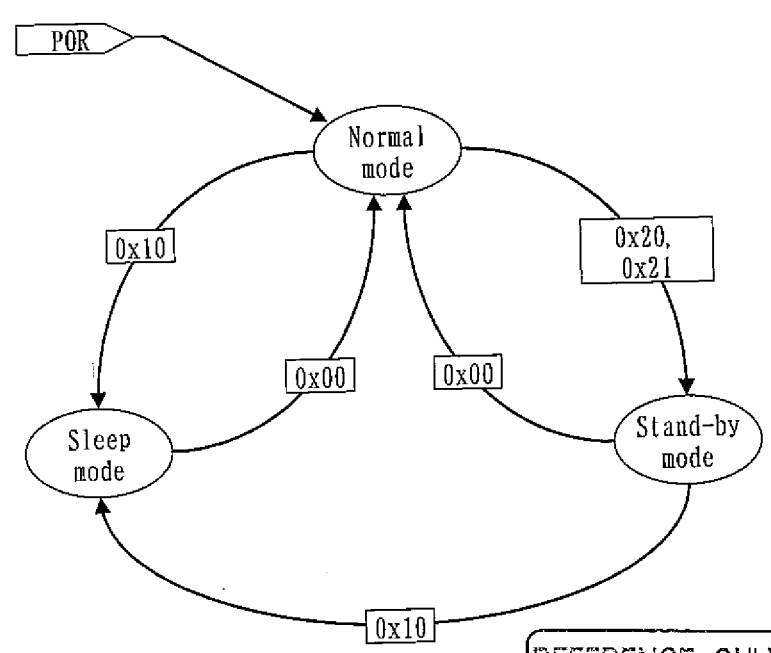

REFERENCE ONLY
 MAY. 15. 2012
 Panasonic
 DEVICE DIVISION
 Ise Factory

DATE : Aug. 30. 2011

TITLE	SPECIFICATIONS FOR Infrared Array Sensor	PAGE	10/26
NAME	Infrared Array Sensor "Grid-EYE"		AMG88**

(2) Reset Register

Register only for writing to reset software.
 Writing in specific code and register makes Software Reset possible.
 There are two kinds of Software Reset.

- ① Flag Reset can all clear the Status Register (0x04) , Interrupt Flag, and Interrupt Table (0x10~0x17) .
- ② Initial Reset brings Flag reset and returns to initial setting.

address	register	R/W	bit7	bit6	bit5	bit4	bit3	bit2	bit1	bit0	Initial value
0x01	RST	W	RST [7:0]								0x00

command	Operating mode
0x30	Flag reset
0x3F	Initial reset
else	-

(3) Frame Rate Register

Register for setting Frame Rate.

bit0: Setting Frame Mode
 1: 1FPS
 0: 10FPS

address	register	R/W	bit7	bit6	bit5	bit4	bit3	bit2	bit1	bit0	Initial value
0x02	FPSC	R/W	-	-	-	-	-	-	-	FPS	0x00

(4) Interrupt Control Register

Register for setting Interrupt Function.

bit1: INTMOD
 1: Absolute Value Interrupt Mode
 0: Difference Interrupt Mode

bit0: INTEN
 1: INT Output active
 0: INT Output reactive (Hi-Z)

address	register	R/W	bit7	bit6	bit5	bit4	bit3	bit2	bit1	bit0	Initial value
0x03	INTC	R/W	-	-	-	-	-	-	INTMOD	INTEN	0x00

REFERENCE ONLY

DATE : Aug. 30. 2011

PANASONIC ELECTRIC WORKS, LTD. SWITCHING DEVICE DIVISION

MAY 15 2012

Panasonic

Corporation

Ise Factory

TITLE	SPECIFICATIONS FOR Infrared Array Sensor	PAGE	11/26
NAME	Infrared Array Sensor "Grid-EYE"		AMG88**

(5) Status Register

Register for only reading to indicate Overflow Flag and Interrupt Flag.

bit3: OVF_THS

1: Thermistor Temperature Output Overflow
(Value of Thermistor (0x0E, 0x0F) : 0xFFFF)

bit2: OVF_IRS

1: Temperature Output Overflow
(Value of Temperature Register (0x80~0xFF) : 0xFFFF)

bit1: INTF

1: Interrupt Outbreak
(Value of Interrupt Table Register (0x10~0x17) : Except for 0x00)

address	register	R/W	bit7	bit6	bit5	bit4	bit3	bit2	bit1	bit0	Initial value
0x04	STAT	R	-	-	-	-	OVF_THS	OVF_IRS	INTF	-	0x00

(6) Status Clear Register

Register for only writing to clear the Overflow Flag and Interrupt Flag.
After writing, automatically turns 0x00.

bit3: OVT_CLR

1: Thermistor Temperature Output Overflow Flag Clear

bit2: OVS_CLR

1: Temperature Output Overflow Flag Clear

bit1: INTCLR

1: Interrupt Flag Clear

address	register	R/W	bit7	bit6	bit5	bit4	bit3	bit2	bit1	bit0	Initial value
0x05	SCLR	W	-	-	-	-	OVT_CLR	OVS_CLR	INTCLR	-	0x00

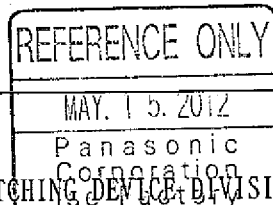

DATE : Aug. 30. 2011

TITLE	SPECIFICATIONS FOR Infrared Array Sensor	PAGE	12/26
NAME	Infrared Array Sensor "Grid-EYE"		AMG88**

(7) Average Register

Register for setting moving average Output Mode.

bit5: MAMOD

1: Twice moving average Output Mode

address	register	R/W	bit7	bit6	bit5	bit4	bit3	bit2	bit1	bit0	Initial value
0x07	AVE	R/W	-	-	MAMOD	-	-	-	-	-	0x00

(8) Interrupt Level Register

Register for setting upper / lower limit Hysteresis on Interrupt Level.

Valid bit is 12 bit. Interrupt Level setting is two's complement setting.

address	register	R/W	bit7	bit6	bit5	bit4	bit3	bit2	bit1	bit0	Initial value
0x08	INTLH	R/W	INT_LVL_H [7:0]								0x00
0x09	INTHH		-				INT_LVL_H [11:8]				
0x0A	INTLL		INT_LVL_L [7:0]								
0x0B	INTLH		-				INT_LVL_L [11:8]				
0x0C	IHYSL		INT_HYS [7:0]								
0x0D	IHYSH		-				INT_HYS [11:8]				

INT_LVL_H [11:0]:

Interrupt Level upper limit setting

When the value is upper than the set value,

Interrupt Output and Interrupt Pixel Table are set.

INT_LVL_L [11:0]:

Interrupt Level lower limit setting

When the value is lower than the set value,

Interrupt Output and Interrupt Pixel Table are set.

INT_HYS [11:0]:

Setting of Interrupt Hysteresis Level

When Interrupt is generated, set Hysteresis Level applied to

Interrupt Level upper / lower value.

When the value is set over Interrupt Level,

Interrupt Output cannot be correct.

REFERENCE ONLY

MAY 15 2012

DATE: Aug. 30. 2011

PANASONIC ELECTRIC WORKS, LTD. SWITCHING DEVICE DIVISION

Panasonic
Ise Factory

TITLE	SPECIFICATIONS FOR Infrared Array Sensor	PAGE	13/26
NAME	Infrared Array Sensor "Grid-EYE"		AMG88**

(9) Thermistor Register

Thermistor Temperature Register is a read only register which indicate Thermistor Temperature Data.

Temperature Data is 12 bit data and 2 byte data.

1 LSB has 12 bit resolution which is equivalent to 0.0625°C and it is indicated as code + absolute value.

Main temperature data are shown below.

address	register	R/W	bit7	bit6	bit5	bit4	bit3	bit2	bit1	bit0	Initial value
0x0E	TTHL	R	T7	T6	T5	T4	T3	T2	T1	T0	0x00
0x0F	TTHH	R	-	-	-	-	+/-	T10	T9	T8	0x00

temperature	Binary number	HEX number
+125°C	0111_1101_0000	0x7D0
+25°C	0001_1001_0000	0x190
+0.25°C	0000_0000_0100	0x004
0°C	0000_0000_0000	0x000
-0.25°C	1000_0000_0100	0x804
-20°C	1001_0100_0000	0x940

(10) Interrupt Table Register

Register for reading only to indicate pixels which temperature outputs are over the threshold.

address	register	R/W	bit7	bit6	bit5	bit4	bit3	bit2	bit1	bit0	Initial value
0x10	INT0	R	PIX08	PIX07	PIX06	PIX05	PIX04	PIX03	PIX02	PIX01	0x00
0x11	INT1	R	PIX16	PIX15	PIX14	PIX13	PIX12	PIX11	PIX10	PIX09	0x00
0x12	INT2	R	PIX24	PIX23	PIX22	PIX21	PIX20	PIX19	PIX18	PIX17	0x00
0x13	INT3	R	PIX32	PIX31	PIX30	PIX29	PIX28	PIX27	PIX26	PIX25	0x00
0x14	INT4	R	PIX40	PIX39	PIX38	PIX37	PIX36	PIX35	PIX34	PIX33	0x00
0x15	INT5	R	PIX48	PIX47	PIX46	PIX45	PIX44	PIX43	PIX42	PIX41	0x00
0x16	INT6	R	PIX56	PIX55	PIX54	PIX53	PIX52	PIX51	PIX50	PIX49	0x00
0x17	INT7	R	PIX64	PIX63	PIX62	PIX61	PIX60	PIX59	PIX58	PIX57	0x00

PIXn:

Setting pixels over the threshold.

1: Pixel* interrupt is generated.

0: Pixel* interrupt is not generated.

Interrupt Table is renewed in timing with when output data is renewed.

Interrupt Table is possible to be cleared by reset register.

PANASONIC ELECTRIC WORKS, LTD. SWITCHING DEVICE DIVISION Corporation Ise Factory	REFERENCE ONLY MAY 15 2012 Panasonic	DATE : Aug. 30. 2011
--	--	----------------------

(11) Temperature Register

Register for reading only to indicate temperature data per 1 pixel.
 Temperature Data of each pixel is 12 bit data and 2 byte data.
 1 LSB has 12 bit resolution (11 bit + sign) which is equivalent to 0.25°C
 and it is indicated as two's complement form.
 Main temperature data are shown below.

address	register	R/W	bit7	bit6	bit5	bit4	bit3	bit2	bit1	bit0	Initial value
0x80	T01L	R	T7	T6	T5	T4	T3	T2	T1	T0	0x00
0x81	T01H	R	-	-	-	-	+/-	T10	T9	T8	0x00

temperature	Binary number	HEX number
+125°C	0001_1111_0100	0x1F4
+25°C	0000_0110_0100	0x064
+0.25°C	0000_0000_0001	0x001
0°C	0000_0000_0000	0x000
-0.25°C	1111_1111_1111	0xFF
-25°C	1111_1001_1100	0xF9C
-55°C	1111_0010_0100	0xF24

Supplement)

Temperature Data of Pixel 1~64 (0x80~0xFF) are renewed in a lump
 in timing with no instruction from external Master.
 (Renewal time depends on the setting frame rate.)
 Because of reading 0x80~0xFF at once,
 old and new temperature data never be mingled in 64 pixels data.

REFERENCE ONLY
 MAY. 15. 2012
 Panasonic
 Corporation
 SWITCHING DEVICE DIVISION

DATE : Aug. 30. 2011

TITLE	SPECIFICATIONS FOR Infrared Array Sensor	PAGE	15/26
NAME	Infrared Array Sensor "Grid-EYE"		AMG88**

4-11 Register Map

※Read/Write column R/W : both of Read & Write, R : Read only, W : Write only

Address	Register Name	Read/Write	Description	Initial value
0x00	PCTL	R/W	Set operating mode (Normal, Sleep etc.)	0x00
0x01	RST	W	Software Reset	0x00
0x02	FPSC	R/W	Frame rate	0x00
0x03	INTC	R/W	Interrupt Function	0x00
0x04	STAT	R	Interrupt Flag, low voltage Flag	0x00
0x05	SCLR	W	Interrupt Flag Clear	0x00
0x06			Reserved	
0x07	AVE	R	Moving Average Output Mode	0x00
0x08	INTHL	R/W	Interrupt upper value (Upper level)	0x00
0x09	INTHH	R/W	Interrupt upper value (Upper level)	0x00
0x0A	INTLL	R/W	Interrupt lower value (Lower level)	0x00
0x0B	INTLH	R/W	Interrupt lower value (upper level)	0x00
0x0C	IHYSL	R/W	Interrupt hysteresis value (Lower level)	0x00
0x0D	IHYSH	R/W	Interrupt hysteresis value (Upper level)	0x00
0x0E	TTHL	R	Thermistor Output Value (Lower level)	0x00
0x0F	TTHH	R	Thermistor Output Value (Upper level)	0x00
0x10	INT0	R	Pixel 1~8 Interrupt Result	0x00
0x11	INT1	R	Pixel 9~16 Interrupt Result	0x00
0x12	INT2	R	Pixel 17~24 Interrupt Result	0x00
0x13	INT3	R	Pixel 25~32 Interrupt Result	0x00
0x14	INT4	R	Pixel 33~40 Interrupt Result	0x00
0x15	INT5	R	Pixel 41~48 Interrupt Result	0x00
0x16	INT6	R	Pixel 49~56 Interrupt Result	0x00
0x17	INT7	R	Pixel 57~64 Interrupt Result	0x00
0x18			Reserved	
0x19			Reserved	
0x1A			Reserved	
0x1B			Reserved	
0x1C			Reserved	
0x1D			Reserved	
0x1E			Reserved	
0x1F			Reserved	

REFERENCE ONLY

MAY. 15. 2012

DATE : Aug. 30. 2011

PANASONIC ELECTRIC WORKS, LTD. SWITCHING DEVICE DIVISION

Corporation
Ise Factory

TITLE	SPECIFICATIONS FOR Infrared Array Sensor	PAGE	16/26
NAME	Infrared Array Sensor "Grid-EYE"		AMG88**

Address	Register Name	Read/Write	Description	Initial value
0x80	T01L	R	Pixel 1 Output Value (Lower Level)	0x00
0x81	T01H	R	Pixel 1 Output Value (Upper Level)	0x00
0x82	T02L	R	Pixel 2 Output Value (Lower Level)	0x00
0x83	T02H	R	Pixel 2 Output Value (Upper Level)	0x00
0x84	T03L	R	Pixel 3 Output Value (Lower Level)	0x00
0x85	T03H	R	Pixel 3 Output Value (Upper Level)	0x00
0x86	T04L	R	Pixel 4 Output Value (Lower Level)	0x00
0x87	T04H	R	Pixel 4 Output Value (Upper Level)	0x00
0x88	T05L	R	Pixel 5 Output Value (Lower Level)	0x00
0x89	T05H	R	Pixel 5 Output Value (Upper Level)	0x00
0x8A	T06L	R	Pixel 6 Output Value (Lower Level)	0x00
0x8B	T06H	R	Pixel 6 Output Value (Upper Level)	0x00
0x8C	T07L	R	Pixel 7 Output Value (Lower Level)	0x00
0x8D	T07H	R	Pixel 7 Output Value (Upper Level)	0x00
0x8E	T08L	R	Pixel 8 Output Value (Lower Level)	0x00
0x8F	T08H	R	Pixel 8 Output Value (Upper Level)	0x00
0x90	T09L	R	Pixel 9 Output Value (Lower Level)	0x00
0x91	T09H	R	Pixel 9 Output Value (Upper Level)	0x00
0x92	T10L	R	Pixel 10 Output Value (Lower Level)	0x00
0x93	T10H	R	Pixel 10 Output Value (Upper Level)	0x00
0x94	T11L	R	Pixel 11 Output Value (Lower Level)	0x00
0x95	T11H	R	Pixel 11 Output Value (Upper Level)	0x00
0x96	T12L	R	Pixel 12 Output Value (Lower Level)	0x00
0x97	T12H	R	Pixel 12 Output Value (Upper Level)	0x00
0x98	T13L	R	Pixel 13 Output Value (Lower Level)	0x00
0x99	T13H	R	Pixel 13 Output Value (Upper Level)	0x00
0x9A	T14L	R	Pixel 14 Output Value (Lower Level)	0x00
0x9B	T14H	R	Pixel 14 Output Value (Upper Level)	0x00
0x9C	T15L	R	Pixel 15 Output Value (Lower Level)	0x00
0x9D	T15H	R	Pixel 15 Output Value (Upper Level)	0x00
0x9E	T16L	R	Pixel 16 Output Value (Lower Level)	0x00
0x9F	T16H	R	Pixel 16 Output Value (Upper Level)	0x00

REFERENCE ONLY

MAY. 15. 2012

DATE : Aug. 30. 2011

PANASONIC ELECTRIC WORKS, LTD. SWITCHING DEVICE DIVISION

Corporation
Ise Factory

TITLE	SPECIFICATIONS FOR Infrared Array Sensor	PAGE	17/26
NAME	Infrared Array Sensor "Grid-EYE"		AMG88**

Address	Register Name	Read/Write	Description	Initial value
0xA0	T17L	R	Pixel 17 Output Value (Lower Level)	0x00
0xA1	T17H	R	Pixel 17 Output Value (Upper Level)	0x00
0xA2	T18L	R	Pixel 18 Output Value (Lower Level)	0x00
0xA3	T18H	R	Pixel 18 Output Value (Upper Level)	0x00
0xA4	T19L	R	Pixel 19 Output Value (Lower Level)	0x00
0xA5	T19H	R	Pixel 19 Output Value (Upper Level)	0x00
0xA6	T20L	R	Pixel 20 Output Value (Lower Level)	0x00
0xA7	T20H	R	Pixel 20 Output Value (Upper Level)	0x00
0xA8	T21L	R	Pixel 21 Output Value (Lower Level)	0x00
0xA9	T21H	R	Pixel 21 Output Value (Upper Level)	0x00
0xAA	T22L	R	Pixel 22 Output Value (Lower Level)	0x00
0xAB	T22H	R	Pixel 22 Output Value (Upper Level)	0x00
0xAC	T23L	R	Pixel 23 Output Value (Lower Level)	0x00
0xAD	T23H	R	Pixel 23 Output Value (Upper Level)	0x00
0xAE	T24L	R	Pixel 24 Output Value (Lower Level)	0x00
0xAF	T24H	R	Pixel 24 Output Value (Upper Level)	0x00
0xB0	T25L	R	Pixel 25 Output Value (Lower Level)	0x00
0xB1	T25H	R	Pixel 25 Output Value (Upper Level)	0x00
0xB2	T26L	R	Pixel 26 Output Value (Lower Level)	0x00
0xB3	T26H	R	Pixel 26 Output Value (Upper Level)	0x00
0xB4	T27L	R	Pixel 27 Output Value (Lower Level)	0x00
0xB5	T27H	R	Pixel 27 Output Value (Upper Level)	0x00
0xB6	T28L	R	Pixel 28 Output Value (Lower Level)	0x00
0xB7	T28H	R	Pixel 28 Output Value (Upper Level)	0x00
0xB8	T29L	R	Pixel 29 Output Value (Lower Level)	0x00
0xB9	T29H	R	Pixel 29 Output Value (Upper Level)	0x00
0xBA	T30L	R	Pixel 30 Output Value (Lower Level)	0x00
0xBB	T30H	R	Pixel 30 Output Value (Upper Level)	0x00
0xBC	T31L	R	Pixel 31 Output Value (Lower Level)	0x00
0xBD	T31H	R	Pixel 31 Output Value (Upper Level)	0x00
0xBE	T32L	R	Pixel 32 Output Value (Lower Level)	0x00
0xBF	T32H	R	Pixel 32 Output Value (Upper Level)	0x00

REFERENCE ONLY
MAY. 15. 2012
Corporation
Ise Factory

DATE : Aug. 30. 2011

PANASONIC ELECTRIC WORKS, LTD. SWITCHING DEVICE DIVISION

TITLE	SPECIFICATIONS FOR Infrared Array Sensor	PAGE	18/26
NAME	Infrared Array Sensor "Grid-EYE"		AMG88**

Address	Register Name	Read/Write	Description	Initial value
0xC0	T33L	R	Pixel 33 Output Value (Lower Level)	0x00
0xC1	T33H	R	Pixel 33 Output Value (Upper Level)	0x00
0xC2	T34L	R	Pixel 34 Output Value (Lower Level)	0x00
0xC3	T34H	R	Pixel 34 Output Value (Upper Level)	0x00
0xC4	T35L	R	Pixel 35 Output Value (Lower Level)	0x00
0xC5	T35H	R	Pixel 35 Output Value (Upper Level)	0x00
0xC6	T36L	R	Pixel 36 Output Value (Lower Level)	0x00
0xC7	T36H	R	Pixel 36 Output Value (Upper Level)	0x00
0xC8	T37L	R	Pixel 37 Output Value (Lower Level)	0x00
0xC9	T37H	R	Pixel 37 Output Value (Upper Level)	0x00
0xCA	T38L	R	Pixel 38 Output Value (Lower Level)	0x00
0xCB	T38H	R	Pixel 38 Output Value (Upper Level)	0x00
0xCC	T39L	R	Pixel 39 Output Value (Lower Level)	0x00
0xCD	T39H	R	Pixel 39 Output Value (Upper Level)	0x00
0xCE	T40L	R	Pixel 40 Output Value (Lower Level)	0x00
0xCF	T40H	R	Pixel 40 Output Value (Upper Level)	0x00
0xD0	T41L	R	Pixel 41 Output Value (Lower Level)	0x00
0xD1	T41H	R	Pixel 41 Output Value (Upper Level)	0x00
0xD2	T42L	R	Pixel 42 Output Value (Lower Level)	0x00
0xD3	T42H	R	Pixel 42 Output Value (Upper Level)	0x00
0xD4	T43L	R	Pixel 43 Output Value (Lower Level)	0x00
0xD5	T43H	R	Pixel 43 Output Value (Upper Level)	0x00
0xD6	T44L	R	Pixel 44 Output Value (Lower Level)	0x00
0xD7	T44H	R	Pixel 44 Output Value (Upper Level)	0x00
0xD8	T45L	R	Pixel 45 Output Value (Lower Level)	0x00
0xD9	T45H	R	Pixel 45 Output Value (Upper Level)	0x00
0xDA	T46L	R	Pixel 46 Output Value (Lower Level)	0x00
0xDB	T46H	R	Pixel 46 Output Value (Upper Level)	0x00
0xDC	T47L	R	Pixel 47 Output Value (Lower Level)	0x00
0xDD	T47H	R	Pixel 47 Output Value (Upper Level)	0x00
0xDE	T48L	R	Pixel 48 Output Value (Lower Level)	0x00
0xDF	T48H	R	Pixel 48 Output Value (Upper Level)	0x00

REFERENCE ONLY

DATE : Aug. 30. 2011

PANASONIC ELECTRIC WORKS, LTD.

MAY 15 2012
SWITCHING DEVICE DIVISION

Corporation
Ise Factory

Address	Register Name	Read/Write	Description	Initial value
0xE0	T49L	R	Pixel 49 Output Value (Lower Level)	0x00
0xE1	T49H	R	Pixel 49 Output Value (Upper Level)	0x00
0xE2	T50L	R	Pixel 50 Output Value (Lower Level)	0x00
0xE3	T50H	R	Pixel 50 Output Value (Upper Level)	0x00
0xE4	T51L	R	Pixel 51 Output Value (Lower Level)	0x00
0xE5	T51H	R	Pixel 51 Output Value (Upper Level)	0x00
0xE6	T52L	R	Pixel 52 Output Value (Lower Level)	0x00
0xE7	T52H	R	Pixel 52 Output Value (Upper Level)	0x00
0xE8	T53L	R	Pixel 53 Output Value (Lower Level)	0x00
0xE9	T53H	R	Pixel 53 Output Value (Upper Level)	0x00
0xEA	T54L	R	Pixel 54 Output Value (Lower Level)	0x00
0xEB	T54H	R	Pixel 54 Output Value (Upper Level)	0x00
0xEC	T55L	R	Pixel 55 Output Value (Lower Level)	0x00
0xED	T55H	R	Pixel 55 Output Value (Upper Level)	0x00
0xEE	T56L	R	Pixel 56 Output Value (Lower Level)	0x00
0xEF	T56H	R	Pixel 56 Output Value (Upper Level)	0x00
0xF0	T57L	R	Pixel 57 Output Value (Lower Level)	0x00
0xF1	T57H	R	Pixel 57 Output Value (Upper Level)	0x00
0xF2	T58L	R	Pixel 58 Output Value (Lower Level)	0x00
0xF3	T58H	R	Pixel 58 Output Value (Upper Level)	0x00
0xF4	T59L	R	Pixel 59 Output Value (Lower Level)	0x00
0xF5	T59H	R	Pixel 59 Output Value (Upper Level)	0x00
0xF6	T60L	R	Pixel 60 Output Value (Lower Level)	0x00
0xF7	T60H	R	Pixel 60 Output Value (Upper Level)	0x00
0xF8	T61L	R	Pixel 61 Output Value (Lower Level)	0x00
0xF9	T61H	R	Pixel 61 Output Value (Upper Level)	0x00
0xFA	T62L	R	Pixel 62 Output Value (Lower Level)	0x00
0xFB	T62H	R	Pixel 62 Output Value (Upper Level)	0x00
0xFC	T63L	R	Pixel 63 Output Value (Lower Level)	0x00
0xFD	T63H	R	Pixel 63 Output Value (Upper Level)	0x00
0xFE	T64L	R	Pixel 64 Output Value (Lower Level)	0x00
0xFF	T64H	R	Pixel 64 Output Value (Upper Level)	0x00

REFERENCE ONLY

MAY. 15. 2012

DATE : Aug. 30. 2011

TITLE	SPECIFICATIONS FOR Infrared Array Sensor	PAGE	20/26
NAME	Infrared Array Sensor "Grid-EYE"		AMG88**

5. Lot No. of manufactured

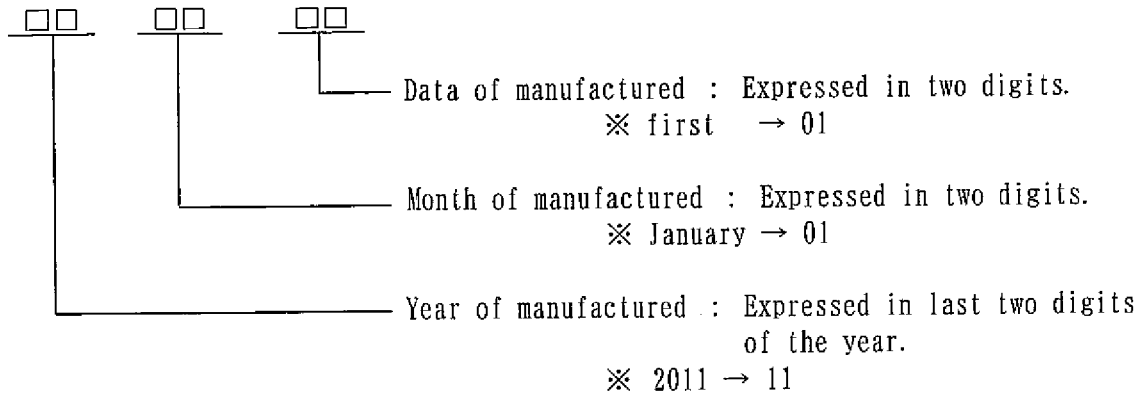

6. Safety Precautions

Safety Precautions

Head the following precautions to prevent injury or accidents.

- ① Do not use these sensors under any circumstance in which the range of their ratings, environment conditions or other specifications are exceeded.
Using the sensors in any way which causes their specifications to be exceeded may generate abnormally high levels of heat, emit smoke, etc., resulting in damage to the circuitry and possibly causing an accident.
- ② Before connecting a connector, check the pin layout by referring to the connector wiring diagram, specifications diagram, etc., and make sure that the connector is connected properly.
Take note that mistakes made in connection may cause unforeseen problems in operation, generate abnormally high levels of heat, emit smoke, etc., resulting in damage to the circuitry.
- ③ Do not use any Infrared Array Sensor which has been disassembled or remodeled.
- ④ Failure modes of sensors include short-circuiting, open-circuiting and temperature rises.
If this sensor is to be used in equipment where safety is a prime consideration, examine the possible effects of these failures on the equipment concerned, and ensure safety by providing protection circuits or protection devices.

Example :

- Safety equipments and devices
- Traffic signals
- Burglar and disaster prevention devices
- Control and safety device for trains and motor vehicles
- Temperature control device using sensor output data. Etc.

TITLE	SPECIFICATIONS FOR Infrared Array Sensor	PAGE	21/26
NAME	Infrared Array Sensor "Grid-EYE"		AMG88**

7. NOTES

7-1 Checkpoints relating to principle of operation

The Infrared Array Sensor is a thermopile-typed infrared sensor which detects quantity of infrared ray.
 Generally, temperature accuracy will be degraded in the following situations.
 Be sure to verify performance and reliability under actual conditions of use and make any necessary temperature corrections.

- There is a heat emitting body located close to where the sensor is mounted.
- A flow of warm or cold air is hitting the sensor.
- The temperature of the sensor is subject to sudden change.
- When an object made of glass, acrylic or other subject which far infrared rays have difficult passing through is located between the sensor and what is to be detected.
- A substance (dirt or water droplets) that makes it difficult for far infrared rays to pass through is attached to the sensor lens.

7-2 Ambient operating conditions

- (1) Temperature : Please refer to Ratings.
- (2) Humidity : 15% to 85% R. H. (No freezing nor condensation at low temperature)
- (3) Atmospheric pressure : 86 to 106 kPa
- (4) Protect the sensor from impact and vibration, because there can cause damage that leads to malfunction and degraded performance.
 And avoid applying a load or impact since this will deform or scratch the lens, making proper operation impossible and causing a deterioration in its performance.
- (5) The sensors do not have a water-proof or dust-proof construction.
 Depending on the ambient operating conditions, some means of providing protection from water and dust and preventing the formation of ice and condensation must be provided prior to using the sensor.
 If condensation occurs, heat source detection response may become delayed by several seconds.
- (6) Please avoid using or storing the pressure sensor chip in a place exposed to corrosive gases (such as the gases given off by organic solvents, sulfurous acid gas, hydrogen sulfides, etc.) which will adversely affect the performance of the infrared array sensor.
- (7) Since the internal circuitry may be destroyed if an external surge voltages is supplied, provide an element which will absorb the surges.
- (8) Malfunctioning may occur if the product is in the vicinity of electrical noise such as that from static electricity, lightning, a mobile phone, an amateur radio, broadcasting station.

REFERENCE ONLY MAY. 15. 2012 PANASONIC CORPORATION Ise Factory		DATE : Aug. 30. 2011
PANASONIC ELECTRIC WORKS, LTD. SWITCHING DEVICE DIVISION		

(9) Although the ambient temperature (humidity) range is a temperature (humidity) range which can operate a sensor continuously, the humidity range changes with temperature. So please use it in the humidity range shown below. And please avoid continuation use near a limit. Generally under high temperature or high humidity, deterioration of electronic parts accelerates. To ensure reliability, please verify quality under conditions of actual use. This humidity range does not guarantee durability ability.

• High gain type (AMG8831, AMG8851)

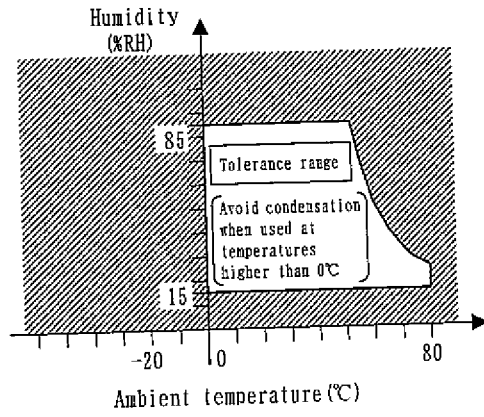

• Low gain type (AMG8832, AMG8852)

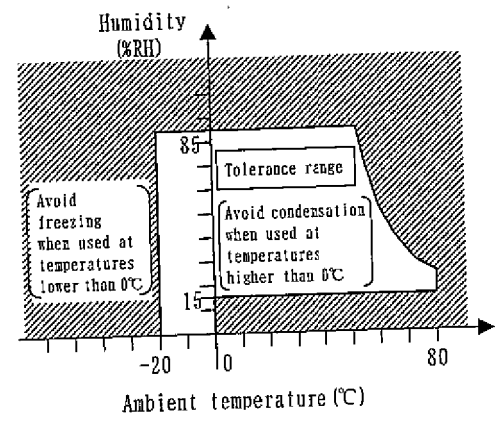

7-3 Mounting

- Use lands on the printed-circuit boards to which the sensor can be securely fixed.
- Recommended printed-circuit board is FR4 (thickness 1.6mm).
- As for mounting unrecommended printed-circuit board, Please verify quality in advance.
- Malfunctioning may occur if much noise is present in the power supply used for this sensor. In order to prevent, in particular, superimposed noise, please install the recommended capacitor between the sensor input terminals (between VDD and GND) closest to the sensor (a position within 20 mm of the pattern circuit length). However, please reselect an ideal capacitor after performing tests on the actual equipment.
- Since the top surface (where the part number is visible) of the sensor is GND, please make sure that the metallic parts of other components do not come into contact.

7-4 Soldering

Due to the thermal capacity of the infrared array sensor is low, therefore, take steps to minimize the effects of external heat. Damage and changes to characteristics may occur due to heat deformation. Use a non-corrosive resin type of flux.

(1) Manual soldering

- Set the soldering tip from 350 to 400°C (30-60W), and solder within 3 seconds or less.
- Please note that output may be changed if the load is applied to the terminals when the soldering.
- Carefully clean the tip of soldering iron.

REFERENCE ONLY
MAY. 15. 2012
Panasonic
SWITCHING DEVICE DIVISION
Ise Factory

DATE : Aug. 30. 2011

TITLE	SPECIFICATIONS FOR Infrared Array Sensor	PAGE	23/26
NAME	Infrared Array Sensor "Grid-EYE"		AMG88**

(2) Reflow soldering

- The recommended reflow temperature profile conditions are given below.
- We recommend the screen solder printing method as the method of cream.
- Please refer to the recommended PC board specification diagram for the PC board foot pattern.
- Self alignment may not always work as expected, therefore, please carefully the position of the terminals and pattern.
- The temperature of the profile is assumed to be a value measured with the printed wiring board of the terminal neighborhood.
- When you do the reflow solder to the back of the PC board after the reflow of the sensor, please execute fixed processing, for instance, with the adhesive etc.

(3) Solder reworking

- Finish reworking in one operation.
- For reworking of the solder bridge, use a soldering iron with a flat tip. Please do not add more flux when reworking.
- The temperature of the soldering tip must be under the above-mentioned temperature.

(4) When you cut or fold the PC board after mounting the sensor, be careful not to stress to the soldered parts.

(5) The sensor terminals are designed to be exposed, so contact of the terminals with metal shards and the like will cause output errors. Therefore, please be careful not to touch the terminals with the metal piece or the hand.

(6) To prevent the insulation of the PC board after soldering, please be careful not to place the chemicals on the sensor when coating.

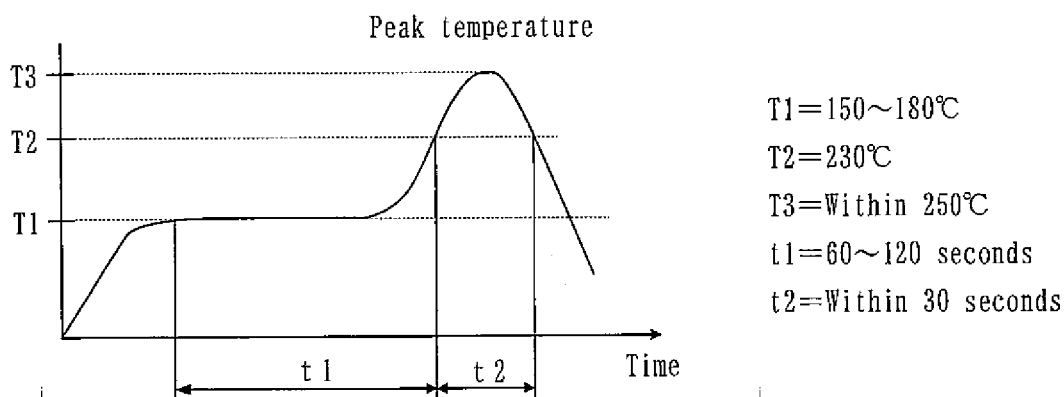

REFERENCE ONLY
 MAY 15 2012
 Panasonic Corporation

DATE : Aug. 30. 2011

TITLE	SPECIFICATIONS FOR Infrared Array Sensor	PAGE	24/26
NAME	Infrared Array Sensor "Grid-EYE"		AMG88**

7-5 Connections

- Please perform connections correctly in accordance with the terminal connection diagram. In particular, be careful not to reverse wire the power supply as this will cause damage or degrade to the sensor.
- Please do not connect wires in an empty terminal. It causes the sensor breakdown.
- When using the sensors with cables, it is recommended that cables which are shielded and as short as possible be used in order to safeguard against the effects of noise.

7-6 Cleaning

Avoid ultrasonic cleaning since this may cause breaks or disconnections in the wiring.

7-7 Transportation and storage

- (1) Extreme vibration and shock during transport will damage the sensor. Handle the outer box and reel with care.
- (2) Storage under extreme conditions will cause soldering degradation, external appearance defects, and deterioration of the characteristics.
The following storage conditions are recommended.
 - Temperature : 0 to 45°C
 - Humidity : less than 70% R. H.
 - Atmosphere : No harmful gasses such as sulfurous acid gas, minimal dust.
- (3) The sensors are sensitive to moisture and come in moisture-proof packages. Observe the following cautions when storing.
 - After the moisture-proof package is unsealed, take the sensors out of storage as soon as possible (within 1 week \leq 30°C 60% R. H.)
 - If the sensors are to be left in storage for a considerable period after the moisture-proof package has been unsealed, it is recommended to keep them in another moisture-proof bag containing silica gel (within 3 months at the most).

* When mounting with solder, if thermal stress is applied to sensors that have absorbed moisture, the moisture will vaporize, swelling will occur, and the inside of the package will become stressed. This may cause the package surface to blister or crack. Therefore, please take caution and observe the soldering conditions.

REFERENCE ONLY

MAY. 15. 2012

DATE : Aug. 30. 2011

Panasonic
DEVICE DIVISION
ISE Factory

PANASONIC ELECTRIC WORKS, LTD. SWITCHING DEVICE DIVISION

TITLE	SPECIFICATIONS FOR Infrared Array Sensor	PAGE	25/26
NAME	Infrared Array Sensor "Grid-EYE"		AMG88**

7-8 Other handling cautions

To assure reliability, check the sensor under actual loading conditions. Avoid any situation that may adversely affect its performance.

- This product may malfunction if dropped on its own before it is installed. Do not use if this happens.
- Caution is required because writing except for register and bit specified in 4-10 can be cause of malfunction and performance degradation.
- Caution is required because differences in the temperature range and the method of connection can lead to breakdown.
- If the sensor get high frequency vibration, it can be cause of breakdown. When the product get impulse like below, do not use it.
 - ① touch to a object made of metal
 - ② touch of mutual sensors
- Since static charge can damage the sensor, bear in mind the following handling precautions.
 - ① Plastic containers should not be used to store or transport the sensors since they readily become charged.
 - ② Please store or transport the product in an environment that hinders the occurrence of static electricity (for example, places with 45% to 60% humidity) and protect the product using electrically conductive packaging.
 - ③ Implement static electricity prevention measures once the product packaging has been opened.
 - Any personnel handling the sensor should wear electrostatic clothing and be body grounded.
 - Place an electrically conducting board on the work surface and ground any devices used such as measuring instruments and jigs.
 - Use a soldering iron with a low leak current or else ground the tip.
 - Make sure that customer equipment used for device assembly is grounded.
 - ④ Since the internal circuitry may be destroyed if an external surge voltage is supplied, provide an element which will absorb the surges.

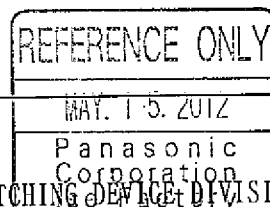

DATE : Aug. 30. 2011

TITLE	SPECIFICATIONS FOR Infrared Array Sensor	PAGE	26/26
NAME	Infrared Array Sensor "Grid-EYE"		AMG88**

8. Special remarks

Although the best attention will be paid for the quality controls of the products, please consider the followings :

- (1) To prevent unexpected failures as much as possible under the conditions not shown in this specifications, please let us know the detailed information on the application, such as the environmental, operational and mounting condition.
- (2) By any chance, if the failure of the product is considered to cause a personal injury or death or property damage, the safety rate should be added to the specified values shown in this specifications and the dual safety structure or circuit is recommended to be taken from the stand point of the Product Liability Indemnity.
- (3) We will either repair or replace any products or parts there of which prove to be defective against only the items written in this specifications within 1 year from the date of products acceptance at the site of delivery.
- (4) Following cases are not covered by this guarantee.
 - ① The case of other damage caused by the failure or defect of the product.
 - ② The case that the product condition changed by handling, storage and/or transportation after delivery.
 - ③ The case caused by the phenomenon which has never been discovered and is impossible to be foreknown with the existing technologies.
 - ④ The case of force majeure, such as acts of God, public enemy or war, fires, floods and any other causes beyond the control of the people concerned.

9. Export control

【To Customers in Japan】

This product is restricted under Japan's "Foreign Exchange and Foreign Trade Law." An export permit from the Japanese government is required when you export or take this product outside Japan. (As of Apr. 2011)

This product may not be used for any purpose other than those specified. Reselling the product to third parties is prohibited.

When disposing of the product, it must first be converted into non-reusable and non-controlled form.

【To Customers Outside Japan】

This product is restricted under Japan's laws and regulations relating to security export control (Foreign Exchange and Foreign Trade Law).

We have obtained an export permit from the Japanese government to sell or provide this product to your company, subject to the following:

This product may not be used for any purpose other than those specified.

This product may be subject to further export restrictions under the laws and regulations of other countries (including your own).

Reselling the product to third parties is prohibited.

When disposing of the product, it must first be converted into non-reusable and non-controlled form.

REFERENCE ONLY

MAY 15 2012

DATE : Aug. 30. 2011

PANASONIC ELECTRIC WORKS, LTD. SWITCHING DEVICE DIVISION

Corporation
Ise Factory

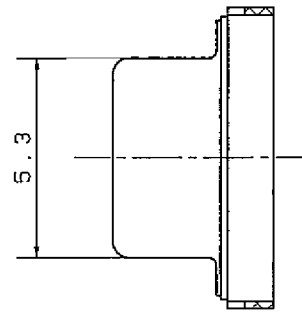
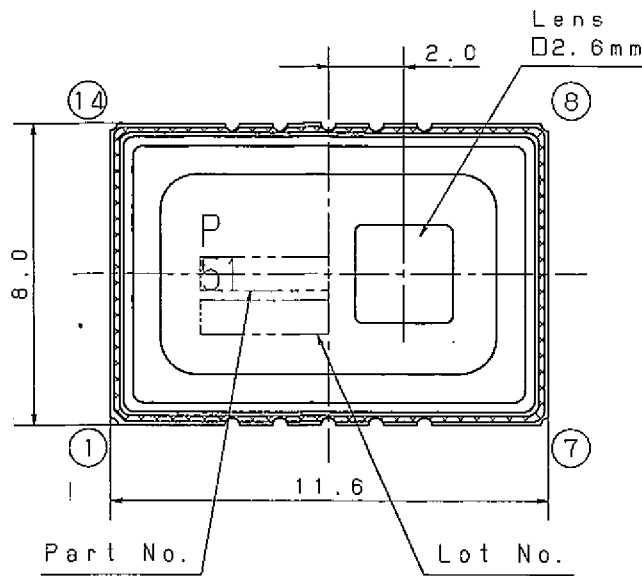

[Recommended PC board pattern]
(TOP VIEW)

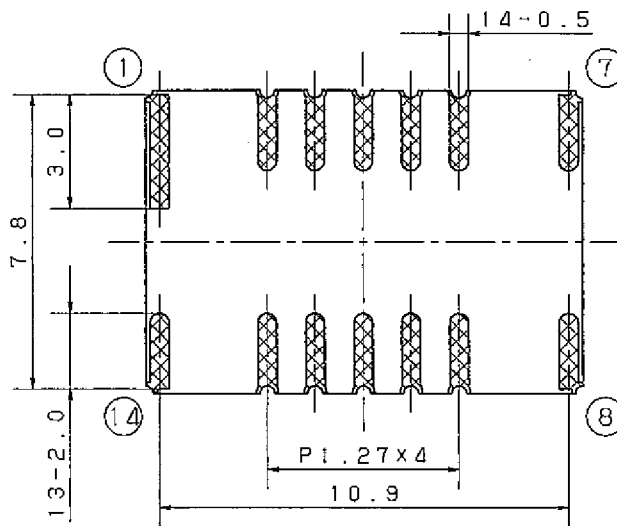
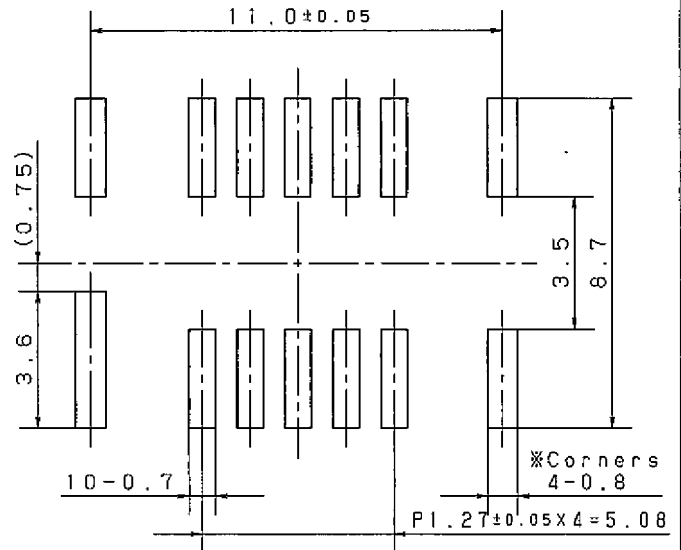
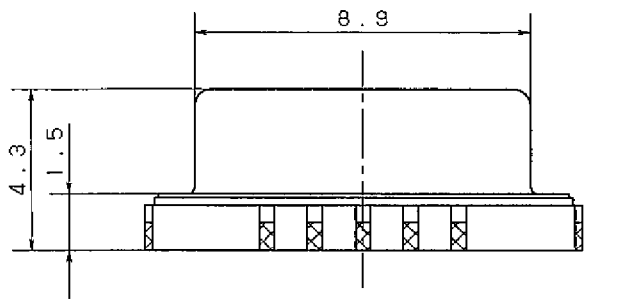

Terminal			
①	NC	⑧	NC
②	SDA	⑨	VDD
③	SCL	⑩	AVDD-PC
④	INT	⑪	NC
⑤	AD_SELECT	⑫	DVDD-PC
⑥	GND	⑬	VPP
⑦	NC	⑭	NC

• Please don't connect wires in NC terminals.

• Please make ⑨ and ⑬ the same electric potential.

General tolerance ; ±0.2

Sym	Item or Code No	Material & Size	qt.	Process	Remark
Catalog No	AMG8851	Drawing Name		DIMENSIONS	
Name	Infrared Array Sensor 'Grid-EYE'	Drawing No		AMG8851	
Remark	REFERENCE ONLY	Scale	5 : 1	Unit:	mm
Drawn	J. Fujis	Date	Aug. 30 '11	Date Aug. 30 '11	
Designed	J. Fujis	Panasonic Electric Works Co., Ltd.		Switching Device Division	
	Yamanaka Yoshiyasu	Panasonic Corporation Ise Factory			